

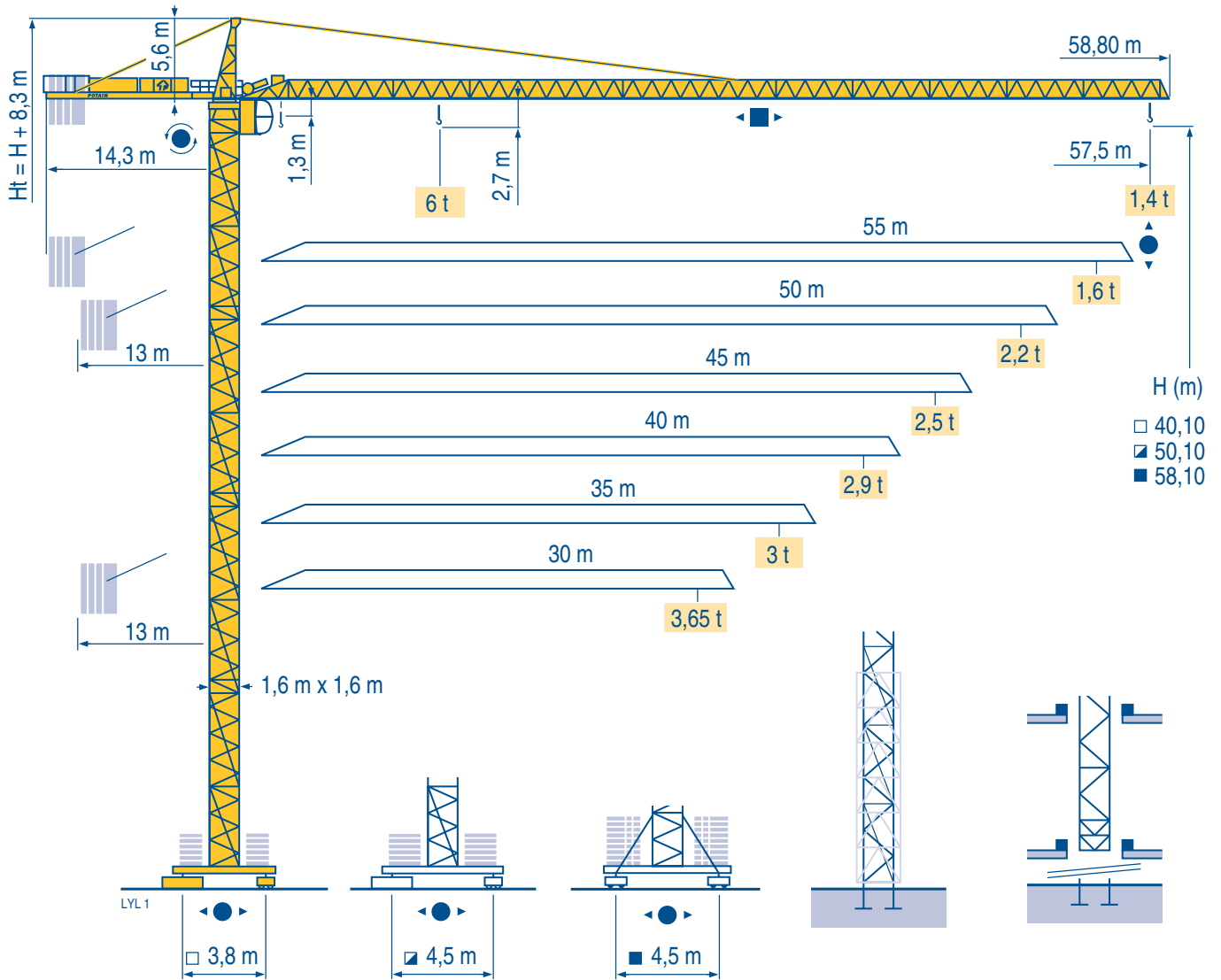

**POTAIN** 

# MD 125 B



## CITY CRANE

**CE** FEM 1.001-A3

**Manitowoc**  
Crane Group

Mat / Réactions City 1,6 m

Maste /  
Eckdrücke  
Masts /  
Reactions  
Reactions  
Mástil /  
Reacciones  
Torre / Reazioni  
Tramo /  
Reações

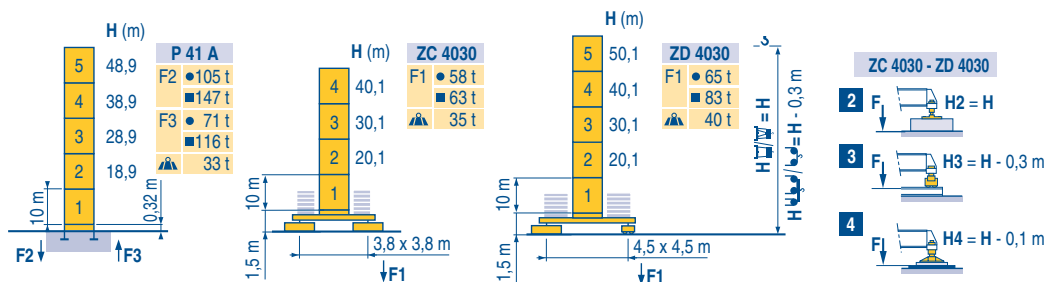

LVL1

Télescopable 1,6 m  
Teleskopierbar 1,6 m  
Telescopico 1,6 m  
Telescopico 1,6 m  
Telescopagem 1,6 m

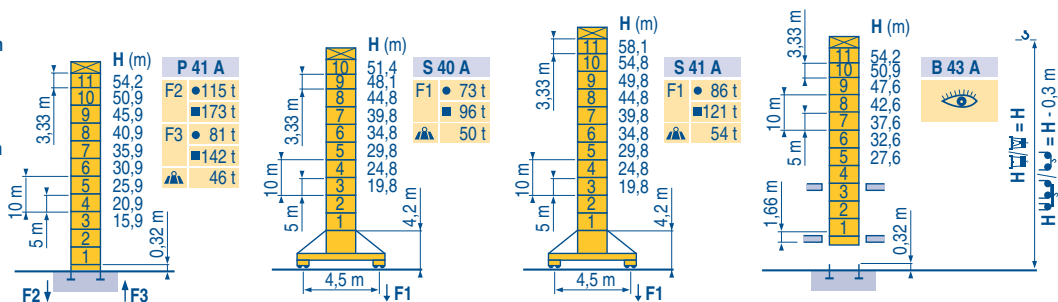

Télescopage sur dalles  
Kletterkrane im Gebäude  
Climbing crane  
Telescopage gruas trepadoras  
Gru in cavedio  
Telescopagem sobre lajes

LVL1

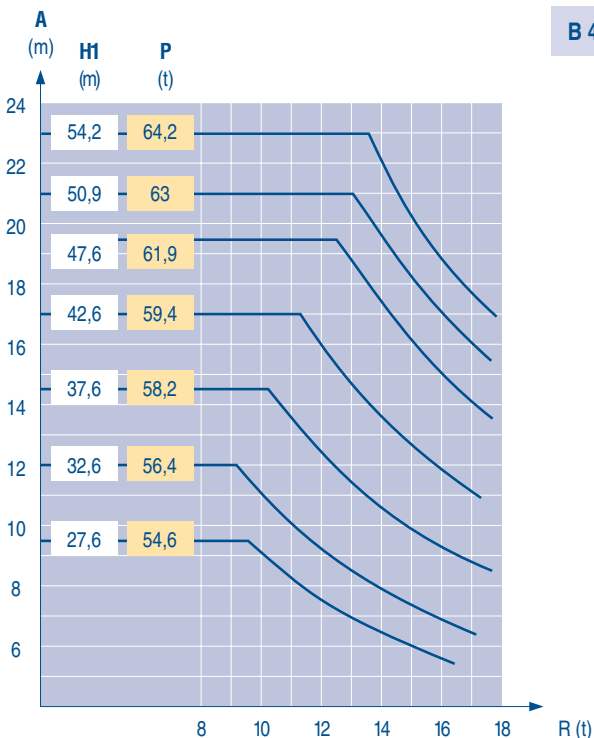
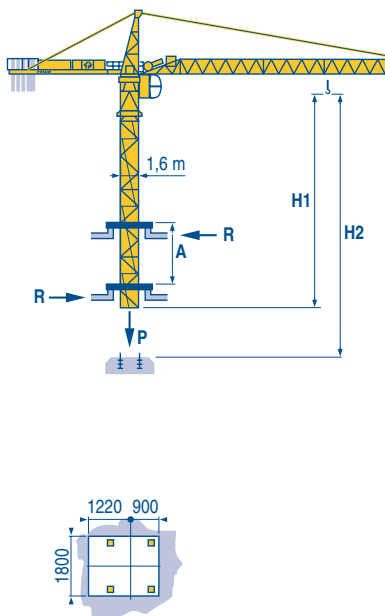

CITY CRANE  
MD 125 B



**F**  
Réactions en service  
Réactions hors service  
A vide sans lest (ni train de transport) avec flèche et hauteur maximum.

**D**  
Reaktionskräfte in Betrieb  
Reaktionskräfte außer Betrieb  
Ohne Last, Ballast (und Transportachse), mit Maximalausleger und Maximalhöhe.

**GB**  
Reactions in service  
Reactions out of service  
Without load, ballast (or transport axes), with maximum jib and maximum height.

**E**  
Reacciones en servicio  
Reacciones fuera de servicio  
Sin carga, sin lastre, (ni tren de transporte), flecha y altura máxima.

**I**  
Reazioni in servizio  
Reazioni fuori servizio  
A vuoto, senza zavorra (ne assali di trasporto) con braccio massimo e altezza massima.

**P**  
Reações em serviço  
Reações fora de serviço  
Sem carga (nem trem de transporte)- sem lastro com lança e altura máximas.

## Courbes de charges

### Lastkurven

### Load diagrams

### Curvas de cargas

### Curve di carico

### Curva de cargas

LVL 1

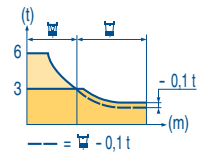
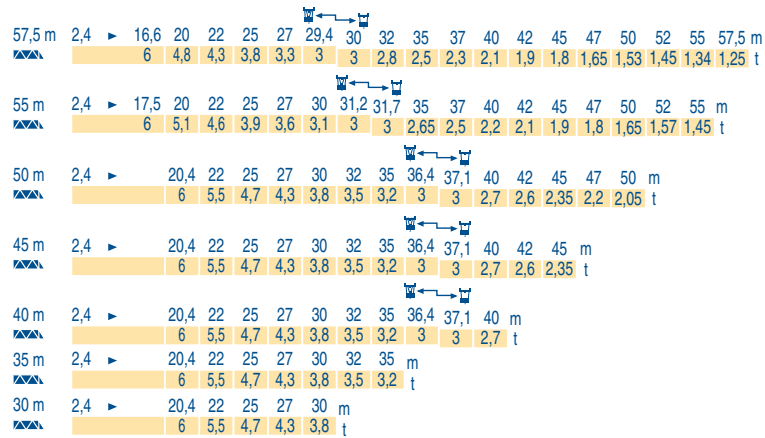
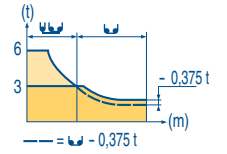
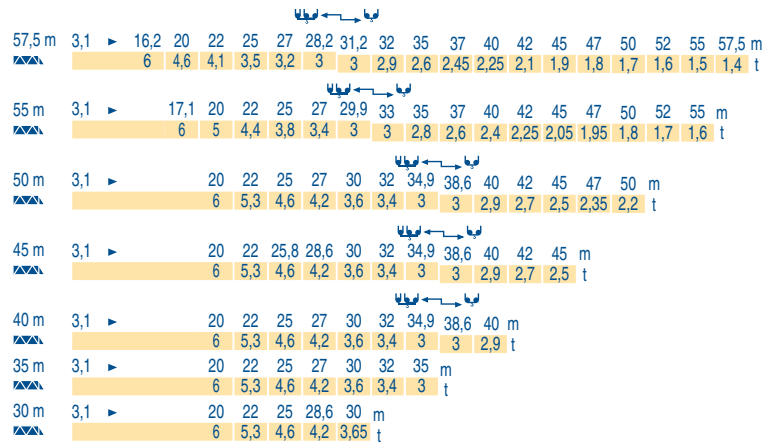

## Lest de contre-flèche

### Gegenauslegerballast

### Counter-jib ballast

### Lastre de contra flecha

### Contrappeso

### Lastros da contra lança

LVL 1

		3450 kg	2250 kg	▲ (kg)
57,5 m	14,3 m	5	-	17 250
55 m	14,3 m	4	1	16 050
50 m	13 m	4	1	16 050
45 m	13 m	3	2	14 850
40 m	13 m	4	-	13 800
35 m	13 m	3	1	12 600
30 m	13 m	2	2	11 400

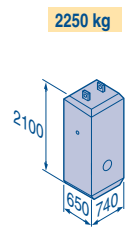
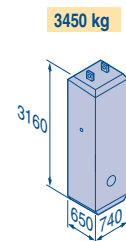

## Lest de base

### Grundballast

### Base ballast

### Lastre de base

### Zavorra di base

### Lastros da base

LVL 1

□1,6 m	ZC 4030 - ● -	H (m)	40,1	30,1	20,1						
		▲ (t)	70	65	60						
□1,6 m	ZD 4030 - ● -	H (m)	50,1	40,1	30,1	20,1					
		▲ (t)	70	55	45	45					
□1,6 m	S 40 A - ● -	H (m)	51,4	48,1	44,8	39,8	34,8	29,8	24,8	19,8	
		▲ (t)	84	72	54	48	42	42	42	36	
□1,6 m	S 41 A - ● -	H (m)	58,1	54,8	49,8	44,8	39,8	34,8	29,8	24,8	19,8
		▲ (t)	114	102	78	54	48	42	42	42	36

## CITY CRANE





### MD 125 B



	F	D	GB	E	I	P
<b>A</b>	Distance entre cadres	Abstand zwischen den Rahmen	Distance between collars	Distancia entra marcos	Distanza fra i telai	Distância entre quadros
<b>H1</b>	Hauteur grue	Kranhöhe	Crane height	Altura grúa	Altezza gru	Altura da grua
<b>P</b>	Poids de la grue(en service)	Krangewicht (in Betrieb)	Crane weight (in service)	Peso de la grúa (en servicio)	Peso della gru (in servizio)	Peso da grua (em serviço)
<b>R</b>	Réaction horizontale	Horizontalkräfte	Horizontal reaction	Reaccion horizontal	Reazione orizzontale	Reacção horizontal
	Voit télescopage sur dalles	Siehe Kletterkrane im Gebäude	See climbing crane	Veja grua trepadora	Consultare gru in cavedio	Ver telescopagem sobre lages





Mécanismes  
Antriebe  
Mechanisms  
Meccanismi  
Mecanismos

LYL 1

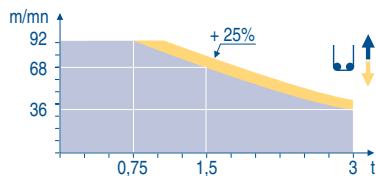
		↑						↑↑						ch - PS hp	kW					
▲	33 LVF 15 Optima	m/min	3 → 12 → 36 → 48 → 68 → 92						1,5 → 6 → 18 → 24 → 34 → 46						30	22	260 m			
		t	3		3		2,25		1,5		0,75		6					6		4,5
◀ ▶	4 D3 V3	m/min	15 - 30 - 58												4	3				
	RCV 145	tr/min U/min rpm	0 → 0,8												2 x 6	2 x 4,4				
ZC 4030 ZD 4030	RT 224	m/min	25												2 x 4	2 x 2,9				
◀ ● ▶	S 40 A R ≥ 10 m	m/min	12,5 - 25												2 x 7	2 x 5,2				
◀ ● ▶	S 41 A A1 2V R ≥ 10 m	m/min	15 - 30												4 x 5	4 x 3,7				
CEI 38		IEC 38	kVA																	
400 V (+6% -10%) 50 Hz			33 LVF : 50 kVA						2000/14											

33 LVF 15  
Optima



	F	D	GB	E	I	P
	Levage	Heben	Hoisting	Elevación	Sollevamento	Elevação
	Distribution	Katzfahren	Trolleying	Distribución	Distribuzione	Distribuição
	Orientation	Schwenken	Slewing	Orientación	Rotazione	Rotação
	Translation	Kranfahren	Travelling	Traslación	Traslazione	Translação
	Conforme aux directives CEE sur le niveau acoustique	Gemäss EWG-Richtlinien für den Schall-Leistungspegel	In compliance with the EEC Instructions on noise level	Conforme con las directivas CEE sobre el nivel acústico	Conforme alle direttive CEE sul livello acustico	Conforme as directivas CEE sobre o nível acústico

 Document commercial non contractuel. Pour toute information technique se référer à la notice correspondante

Unverbindliches Vertriebsdokument. Für technische Informationen, siehe die entsprechenden Anweisungen.

This commercial document is not legally binding. For any technical information, please refer to the corresponding instructions.

Documento commercial non contractual. Para cualquier información técnica, ver la noticia correspondiente.

Documento commerciale non vincolante, per tutte le informazioni tecniche fare riferimento al catalogo istruzioni

Documento comercial não vinculante. Para qualquer informação técnica complementar consultar as respectivas instruções

**Laurer**  
BAUMASCHINEN

www.laurer.at  
office@laurer.at  
+43 52 44 69 66



**Manitowoc**  
Crane CARE

**POTAIN**   
Manitowoc Crane Group

18, rue de Charbonnières - B.P.173  
69132 ECULLY Cedex - France

Tél. : (33) 4 72 18 20 20  
Fax. : (33) 4 72 18 20 00  
www.manitowoccrane.com www.potain.com

**Americas**  
Tel: +1 920 683 6322  
Tel: +1 717 597 8121

**Europe - Middle East - Africa**  
Tel: +(33) 4 72 81 50 00  
Tel: +(44) 191 565 6281

**Asia - Pacific**  
Tel: +(65) 6861 7133  
Fax: +(65) 6862 4142

www.manitowoccrane.com

**CITY CRANE MD 125 B**  
Réf. 2003 48 LYL 1

Copyright.Reproduction interdite © POTAIN 2003

Réalisation HeadLines